



NOTES:



- 1 VORTEX COOLER REQUIRES 35-40 SCFM @ 80-100 PSIG DEWPOINT ≤ -40°F RECOMMENDED. TYPICAL CYCLE IS 20% ON.
- 2 UNIT HEIGHT VARIES PER FLANGE OPTIONS, +1", -4"
- 3 LIFTING WEIGHT: 150LBS. NOTE THAT THE EYELET IS NOT LOCATED DIRECTLY ABOVE CENTER OF GRAVITY
- 4 HEATED SAMPLE LINE RECOMMENDED @ 140°F MINIMUM FOR MOST APPLICATIONS.
- 5) SAMPLE FLOW RECOMMENDED 1-4 L/M
- 6 CUSTOMER I.D. TAG IF SPECIFIED ON PO. ENGRAVED STAINLESS SECURED WITH SCREWS OR RIVETS.
- 7 THE RTD EXTENDS INTO THE MAIN COLUMN AND MUST BE REMOVED PRIOR TO REMOVING THE DISC ASSEMBLY. RTD TO BE INSTALLED UTILIZING A BORED-THRU COMPRESSION FITTING FOR EASE OF REMOVAL AND PROPER SEAL.
- 8 SERIAL/PORT NUMBER LABEL INSIDE ON DOOR.

5200 Convair Drive Carson City, NV 89706 PH(775)883-2500 FAX (775)883-6388		8	03/23/18	UPDATE EXHAUST RTD	CS	BW
 		REV DATE	DESCRIPTION		DWN/AVD	
REVISIONS						
DISTILLATION PROBE REMOTE CONTROL, AIR COOLED		DATE	SCALE	SIZE	SHEET	
PART NO.		02/02/2017	NTS	D	1 OF 4	
FOR		DRAWN BY	ECO#	DRAWING NO.		
1221-RC-V		C. SHIELDS	-	P2785		
		APVD BY				
		B. WOLF				

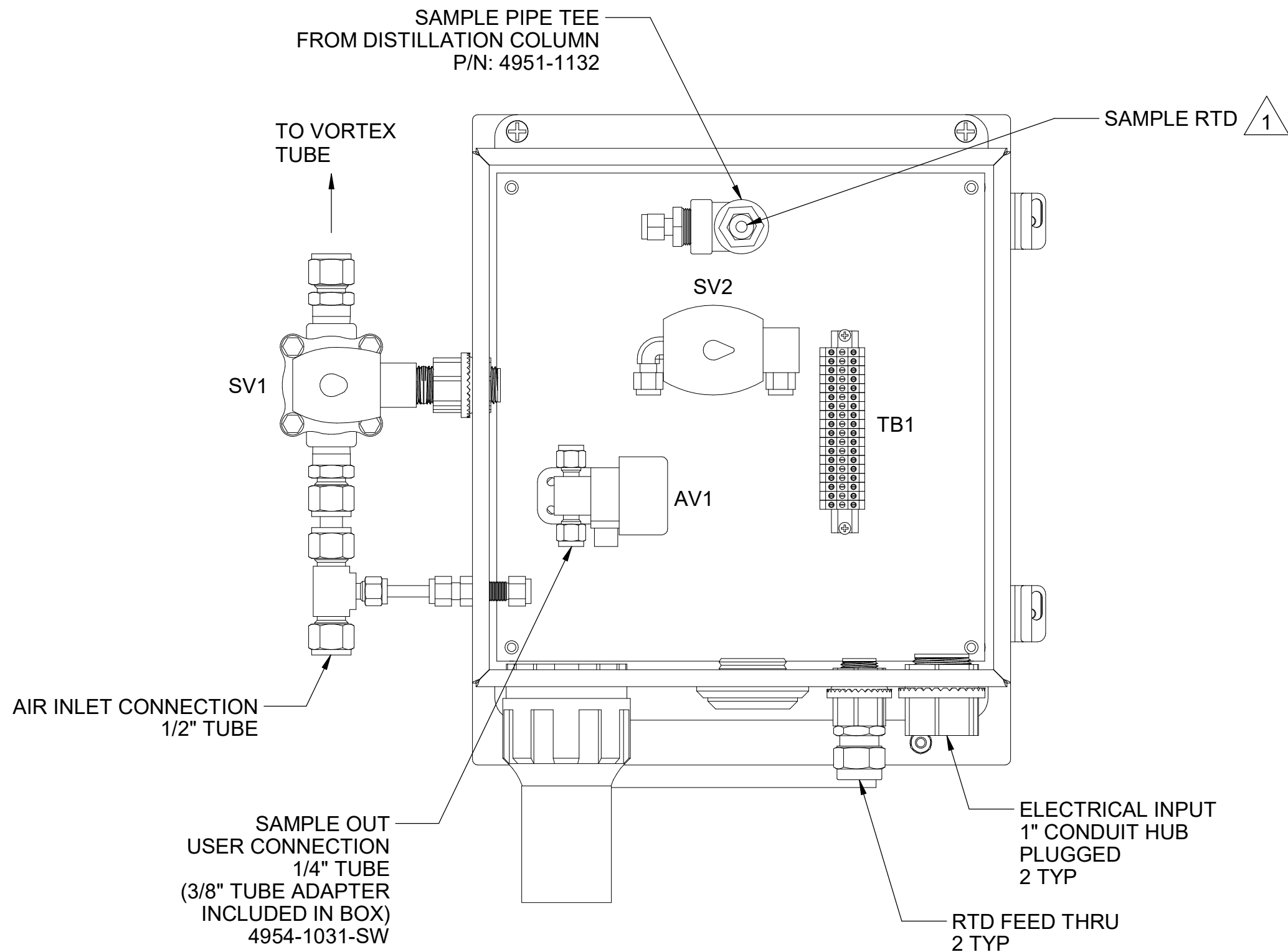

NOTES:

1 THE RTD EXTENDS INTO THE MAIN COLUMN AND MUST BE REMOVED PRIOR TO REMOVING THE DISC ASSEMBLY. RTD TO BE INSTALLED UTILIZING A BORED THRU COMPRESSION FITTING FOR EASE OF REMOVAL AND PROPER SEAL.

5200 Convair Drive Carson City, NV 89706 PH(775)883-2500 FAX (775)883-6388		8	03/23/18	UPDATE EXHAUST RTD	CS	BW
 		REV DATE		DESCRIPTION	DWN/APPV	
REVISIONS						
INTERIOR LAYOUT		DATE	SCALE	SIZE	SHEET	
		01/05/2017	NTS	D	2 OF 4	
PART NO.	FOR	DRAWN BY	ECO#	DRAWING NO.		
1221-RC-V	-	C. SHIELDS	-	P2785		
		APVD BY				
		B. WOLF				

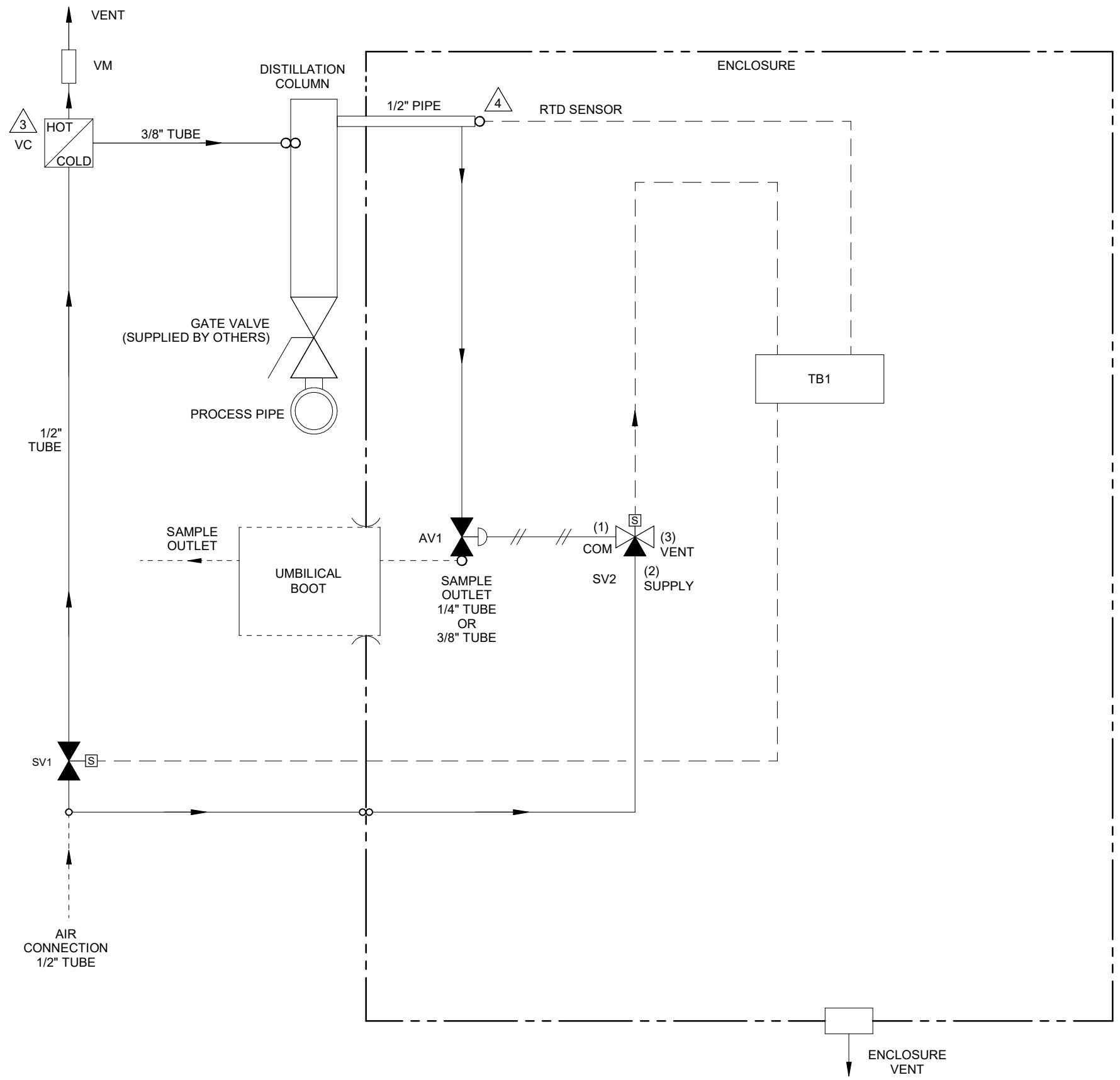

- NOTES:
1. ALL TUBING TO BE 1/4" 316SS (UNLESS OTHERWISE NOTED).
 2. ALL WETTED MATERIALS ARE STAINLESS STEEL.
- △3 SET VORTEX TUBE 3.5 TURNS FROM BOTTOM.
- △4 BORED OUT FITTING 4954-1095-SW.

ITEM	QTY	DESCRIPTION	UAI PART NO.
AV1	1	AIR ACTUATED VALVE 1/4" N.C. SPRING RETURN	4955-0109
SV2	1	SOLENOID VALVE 3-WAY 24VDC EXP. PROOF	4955-0260
SV1	1	SOLENOID VALVE 2-WAY 24VDC EXP. PROOF	4955-1141
VC	1	VORTEX COOLER 40 SCFM	4960-1013
VM	1	VORTEX MUFLER - HOT	4960-1011

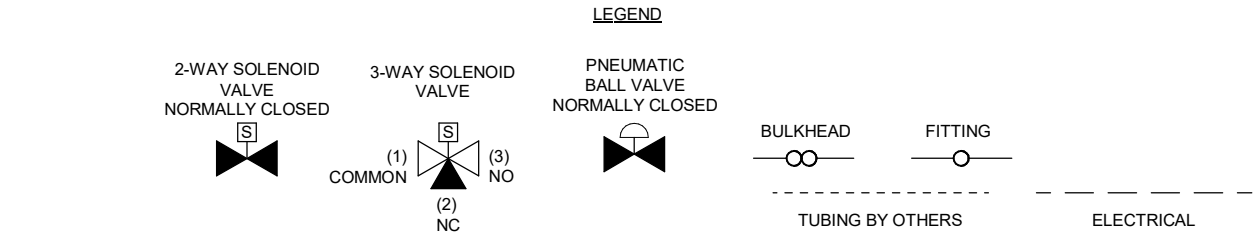

5200 Convair Drive Carson City, NV 89706 PH(775)883-2500 FAX (775)883-6388		8	03/23/18	UPDATE EXHAUST RTD	CS	BW
UNIVERSAL Analyzers Inc. AMETEK		REV DATE		DESCRIPTION	DWN/DPVD	
P & ID		DATE		SCALE	SIZE	SHEET
PART NO.		01/05/2017		NTS	D	3 OF 4
FOR		DRAWN BY C. SHIELDS		ECO#	DRAWING NO.	
1221-RC-V		APVD BY B. WOLF		-	P2785	

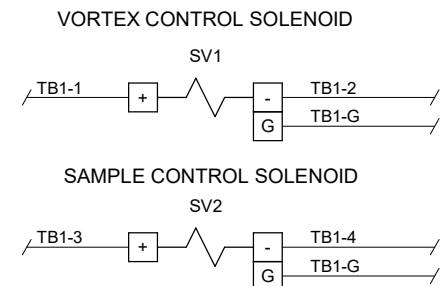
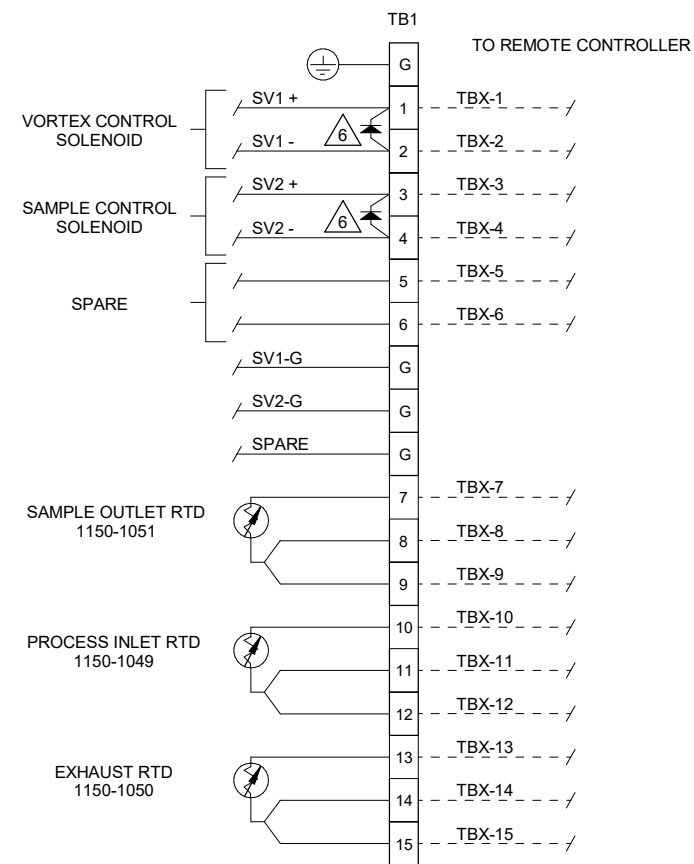

NOTES:

- ELECTRICAL CLASSIFICATION DESIGNED FOR CLASS 1, DIV2, GROUPS A, B, C, D. ALL ELECTRICAL COMPONENTS ARE SELF-CERTIFIED FOR HAZARDOUS AREA USAGE BY THE RESPECTIVE VENDOR. THIS ASSEMBLY HAS NOT BEEN CERTIFIED.
- WIRING SHALL BE IN ACCORDANCE WITH APPLICABLE NEC CODE. ELECTRICAL MATERIALS SHALL BE LABELED BY: UL, FM OR CSA (WIRE AND TERMINALS ONLY) THE FOLLOWING WIRE SIZES ARE EXCLUSIVE OF INTEGRATED COMPONENT WIRE SIZE: ALL WIRES: TFE 300V INSULATION, 18 AWG MINIMUM, STRANDED COPPER CONDUCTOR

3) COLOR CODING:

<u>AC</u>	<u>DC</u>	<u>SIGNAL & ALARM</u>
H/L1 - BLACK	POSITIVE - RED	ALL - YELLOW
N/L2 - WHITE	NEGATIVE - BLUE	
GROUND - GREEN		

4) ENCLOSURE DOOR SHALL BE GROUNDED TO BACK PANEL

5) LABEL ALL CONNECTIONS WITH GRAVOLPHY

6) INSTALL DIODE 1009-0009 FOR ALL SOLENOIDS

FIELD TO WIRE

5200 Convair Drive Carson City, NV 89706 PH(775)883-2500 FAX (775)883-6388		8	03/23/18	UPDATE EXHAUST RTD	CS	BW
		REV DATE		DESCRIPTION	DWN/APPV	
		DATE		SCALE	SIZE	SHEET
PART NO.		FOR		DRAWN BY	ECO#	DRAWING NO.
1221-RC-V		-		C. SHIELDS	-	P2785
		APVD BY		B. WOLF		